



NIKO

Overhead Conveyor Systems

FOR PAINTING LINES

Case study evaluation



Light Cranes
Painting Lines

Conveyor systems

Monorails

Suspension Tool System



We have over 45 years experience in producing high quality sliding door fittings and overhead conveyor systems at the right price, with close contact to suppliers and customers and continuous product development.

NIKO Overhead Conveyor System will provide you with the advantage you need for your painting line.

Our guiding principle is **NIKO QUALITY IN MOTION.**

AUSTRIA

NIKO Vertriebs GmbH

Hainfelder Straße 48
A - 2560 Berndorf
Tel. 0043 2672-21201
Fax 0043 2672-21201-13
office.at@niko.eu.com
www.niko.world

**CHINA-NIKO TRADING
(SHANGHAI) Co., Ltd**

Room 605, Building #13, No.354
Linghe Road, Pudong District,
P.R.China - 200120 Shanghai
Tel. 0086 139 1814 5645
info.cn@niko.eu.com

GERMANY

NIKO Technik GmbH

Robert-Bosch-Str. 14
DE - 42489 Wülfrath
Tel. 0049 (0) 2058 9093603
Fax 0049 (0) 2058 9093604
office.de@niko.eu.com

GREECE

Helm Hellas S.A.

82nd Km Athens-Korinthos
P.O. Box 209
GR - 201 00 KORINTHOS
Tel. 0030 27410 76800
Fax 0030 27410 25368
info@niko.eu.com

Global LOCATIONS & HEAD OFFICE

Power Chain Conveyors

Manual Conveyor Systems

Jib Cranes

Festoon Systems & Cable trolleys

Conductor bars

Fall Arrest Systems

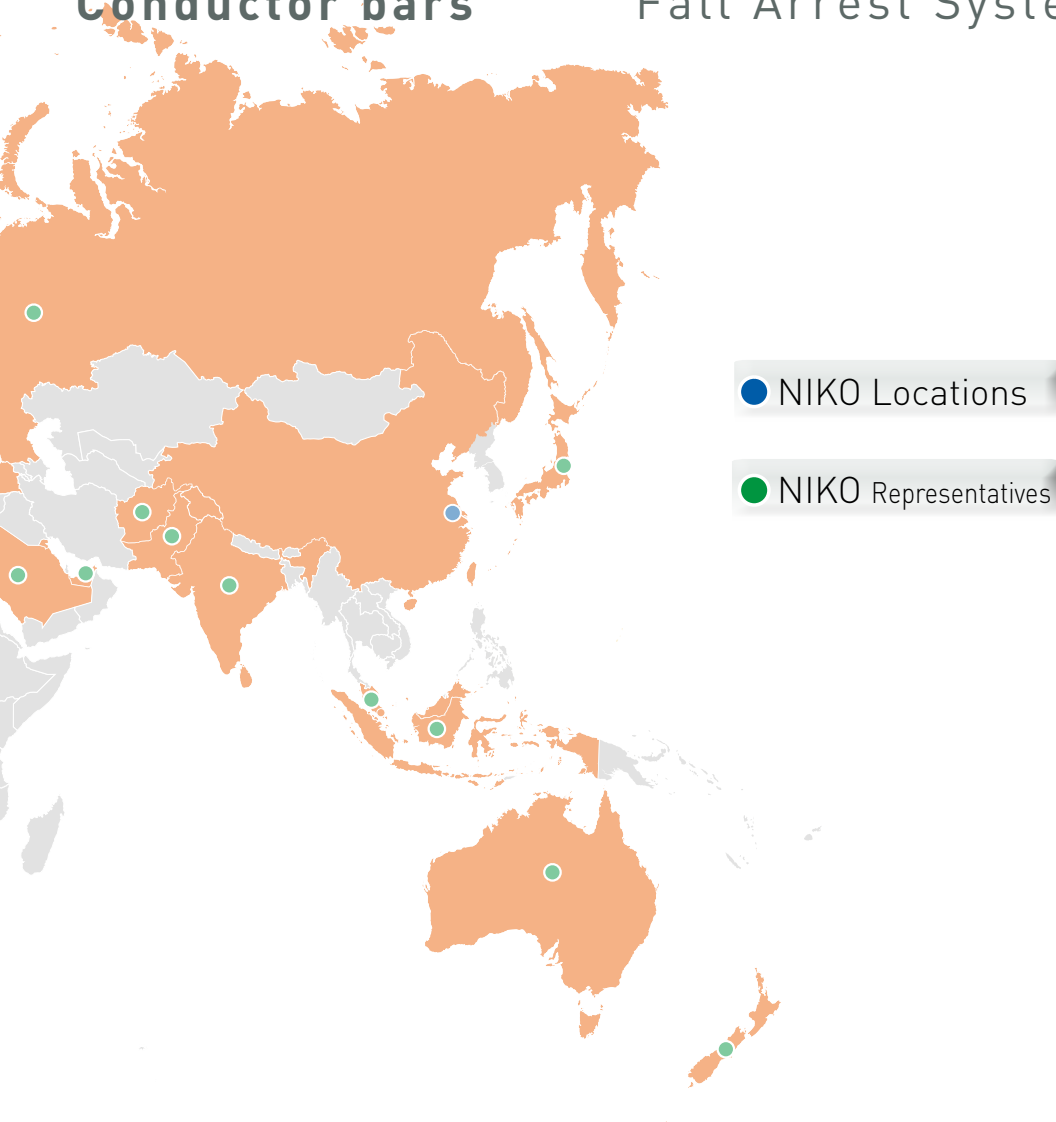

POLAND
NIKO Polska
Wojska Polskiego 65A
PL - Wielun 98-300
Tel. 0048 504 00 35 56
info.pl@niko.eu.com

UNITED KINGDOM
NIKO Ltd
Units 15-21, Insight Park
Welsh Road East, Southam
Warwickshire, CV47 1NE -UK
Tel. 0044 (0) 1926 813111
Fax 0044 (0) 1926 815599
Sales@niko.co.uk
www.niko.co.uk

USA
NIKO Track
300 Highpoint Ave
USA - Portsmouth, RI. 02871
Tel. 001 (0) 401 683 7525
Fax 001 (0) 401 293 3848
info@nikotrack.com
www.nikotrack.com





PAINTING LINE - EXAMPLE 1

NIKO power chain conveyor system with swivel switches



High productivity achieved utilising mechanically automatic switches



The best value for money solution



Power side transfer through the painting booth



Optimal space utilization inside the oven



Spacious parking areas for the flight bars

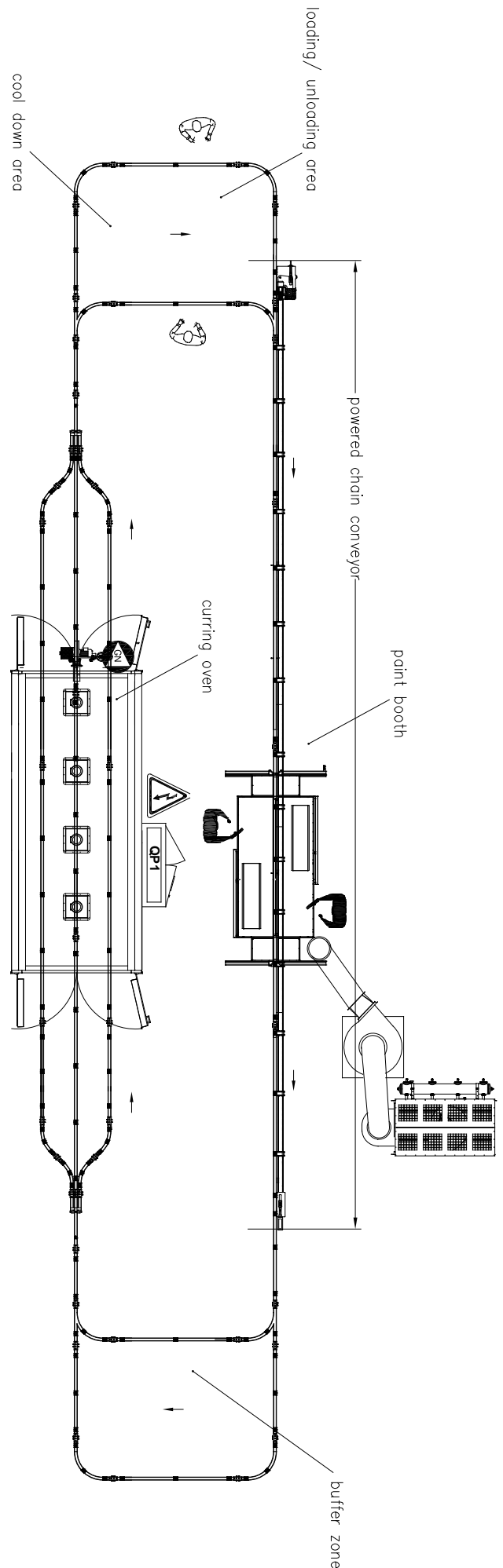

PAINTING LINE-EXAMPLE 2

NIKO power chain conveyor

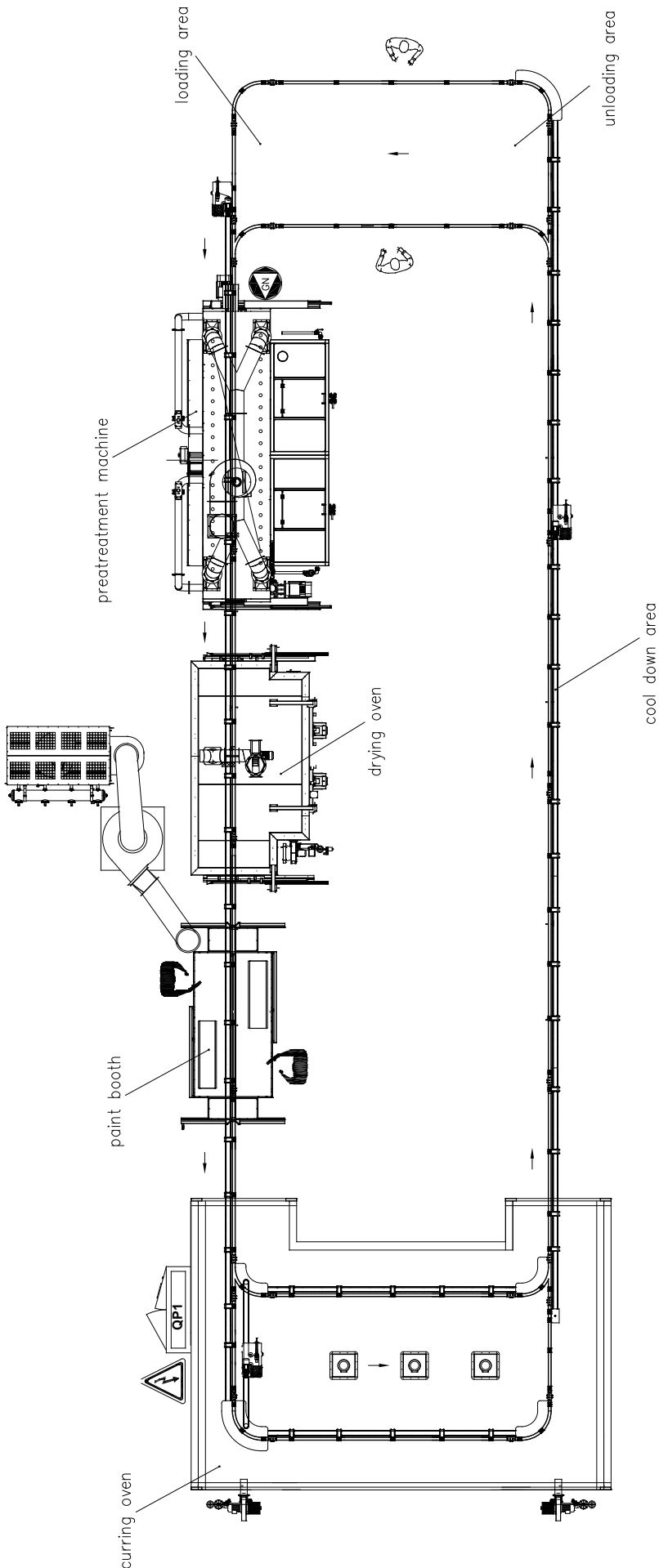

Less labor cost



Automatic flight bar transportation in consecutive stages of production process



Increased production in the curing oven (parallel movement of flight bars into oven)



Power side transfer except loading/unloading area



PAINTING LINE - EXAMPLE 3

Completely powered NIKO conveyor system



Completely powered system with power chain conveyor and wagon with power driven trolley



High productivity



Less labor cost



Automatic loading/unloading of flight bars in crane wagon



Automatic connection between crane wagon lines and conveyor system

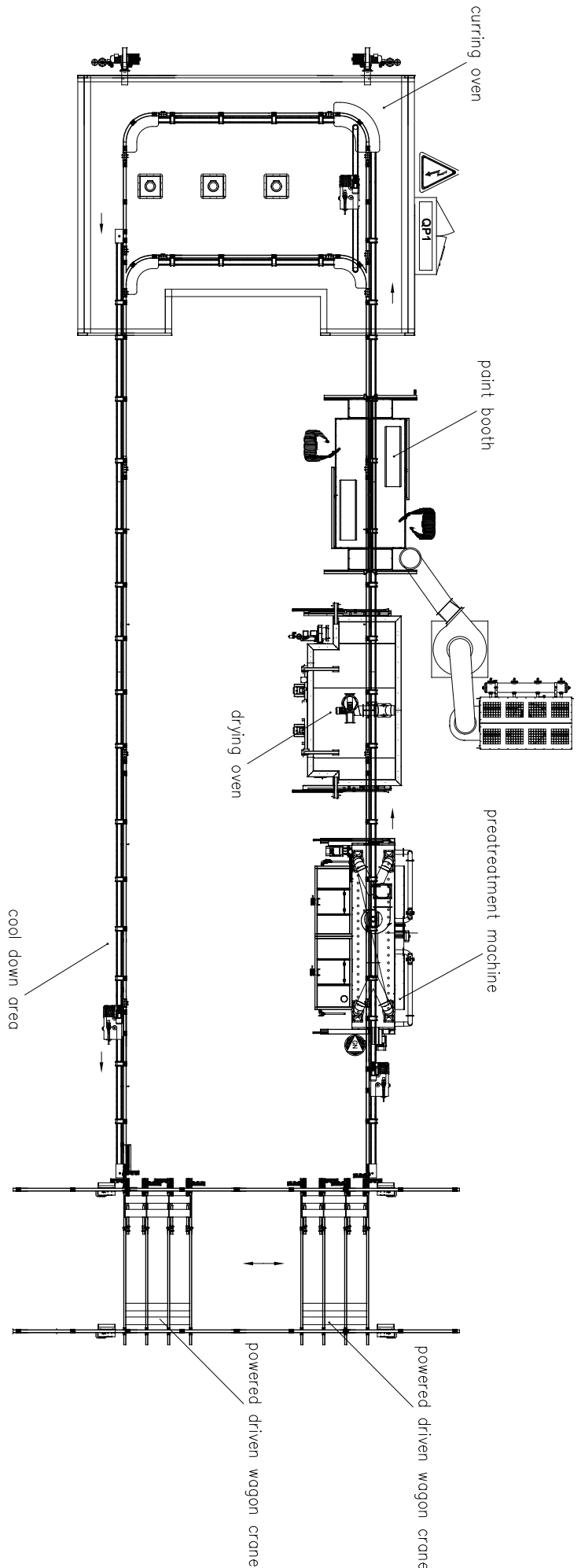

NIKO power chain conveyor with pneumatic turntables

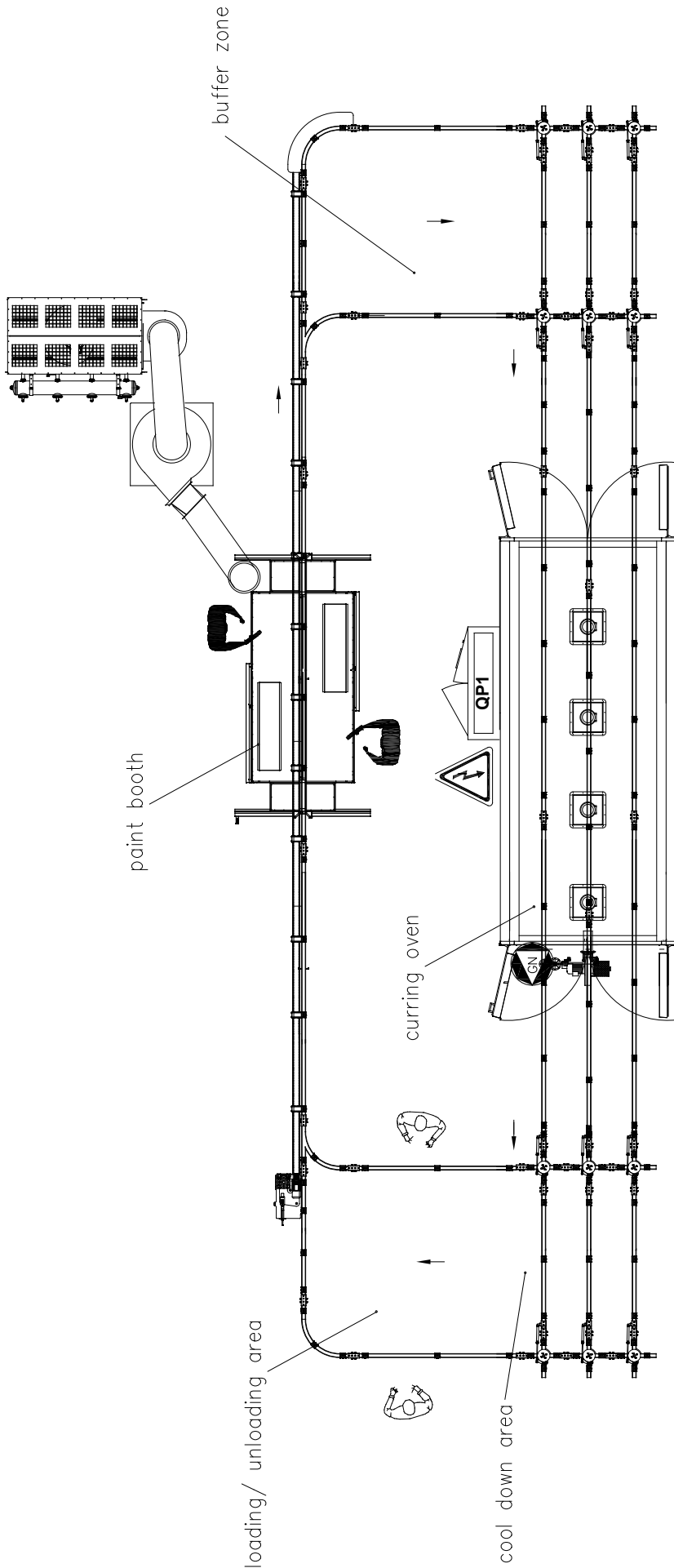

Minimum space requirements utilizing pneumatic turntables



Power side transfer through the paint booth



Value for money solution



Optimal space utilization inside the oven



PAINTING LINE - EXAMPLE 5

NIKO conveyor systems with crane wagons and power chain in the painting booth



Low cost solution



Power side transfer through the paint booth



Optimal space utilization inside the oven



Easier operation in pushing/pulling loads



Ergonomically designed crane wagons

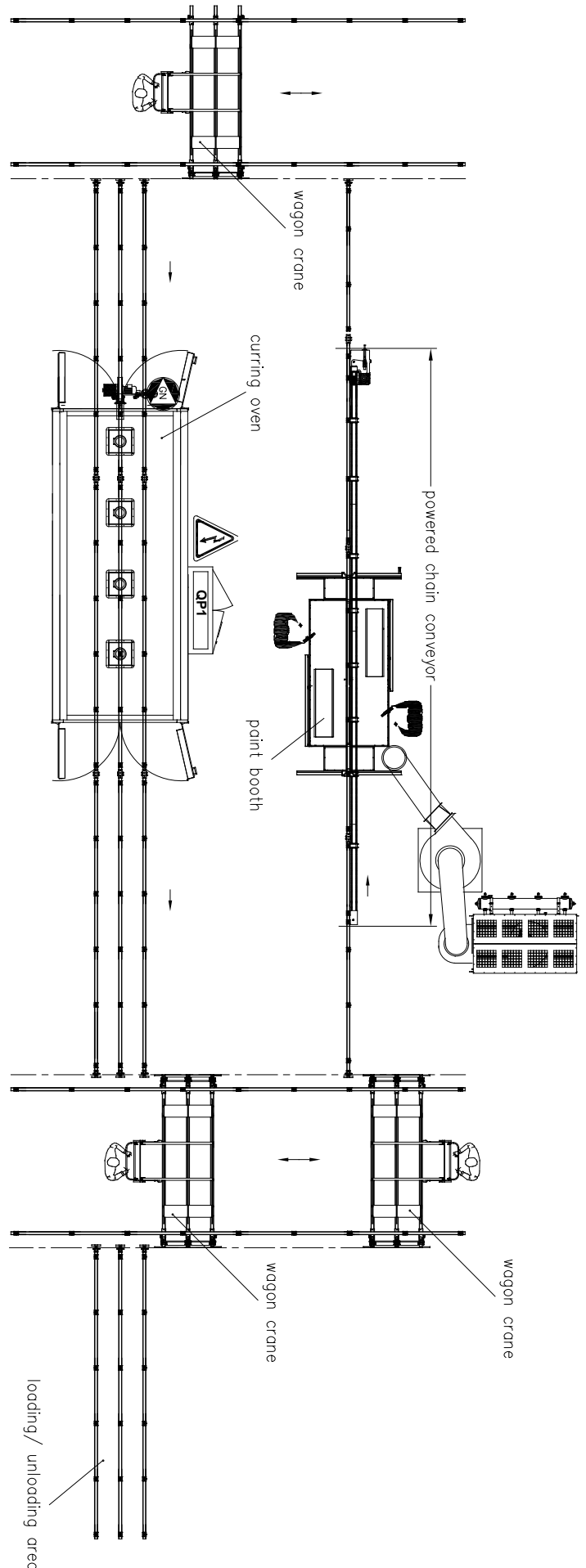

Evaluation of NIKO conveyor systems: 3 case studies

The purpose of this case study is the evaluation of the power paint coating installations provided by the Greek company NIKO.

NIKO company systems will be analysed and compared with systems commonly used in the industry, by highlighting the main parameters making the customer investment advantageous. The evaluation will be based on the following criteria:

A. System Productivity

The number of products painted by the painting line per operation day.

B. Human resources costs

A minimum number of employees is required for the correct operation of the system. The average cost per operation day (2 shifts) and per operator, has been evaluated at 140 €.

C. Installation Housing Costs

The industrial space required for the installation of the system. The cost per square meter of the system is evaluated at 3€ and the operation days of the system at 22 per month.

D. Total cost of equipment

The total cost of equipment is referred to the following costs: curing oven, painting booth, drying oven, washing room and the cost of the conveyor system.

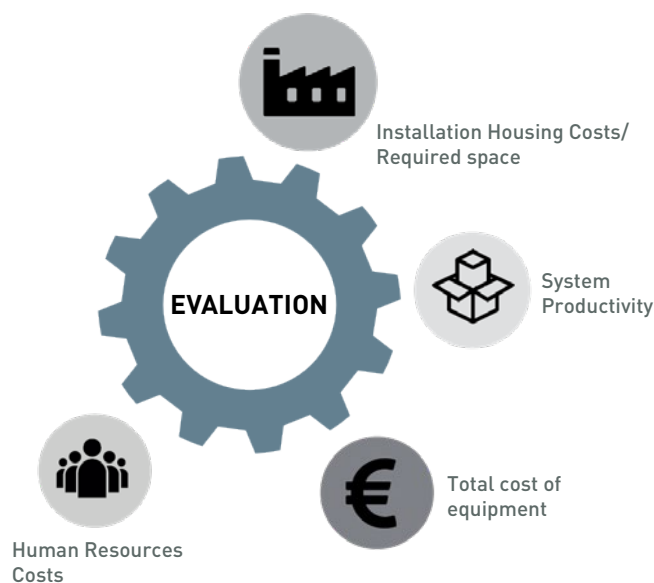

Loading Procedure:

The components are loaded onto the conveyor system of the painting line.

Cleaning Procedure - Preparation:

The components are chemically cleaned for the removal of possible corrosion, lubricants and any residues of previous processing. The cleaning procedure is essential prior to the powder paint coating.

Drying Procedure: Following the chemical cleaning and the surface activation of the material, the painting line continues with the drying of the components. The duration of the drying procedure is 7 minutes at an oven temperature of 80°C.

Powder Paint Coating Procedure: The powder paint is applied to metal parts (aluminium profiles, metal frames, casting parts etc.) using special spray guns. The spray gun positively charges the powder particles, causing repulsion between them, resulting in the even spreading of paint using compressed air. The parts are earthed, attracting the powder particles and ensuring an more even coat of paint, in comparison to wet paint methods.

Curing Procedure: The painting line continues with the hardening of the powder paint coat. The components are exposed to an oven temperature of 180°-200°C, for approximately 20 minutes, allowing the powder paint to develop into an even dry protective film.

Unloading Procedure: The components are removed from the curing oven, are unloaded from the conveyor system and are made available for quality control and packaging.

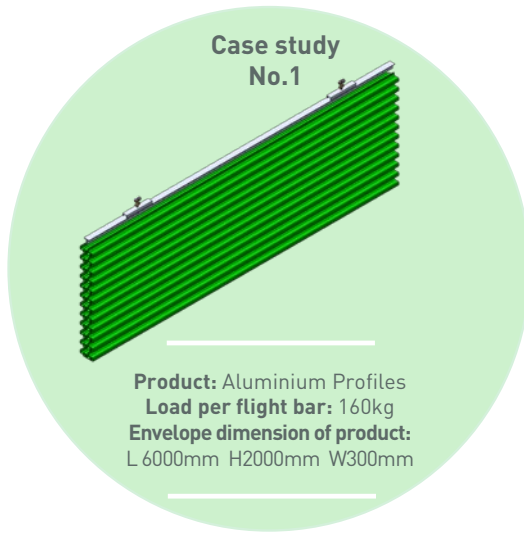

A TYPICAL SOLUTION
 Continuous running conveyor



Total cost of conveyor:
75.000€



Total cost of equipment
190.000€



Required space:
1.100m²



Operators: 5



Painting parts / day:
650 pieces

ALUMINIUM PROFILES

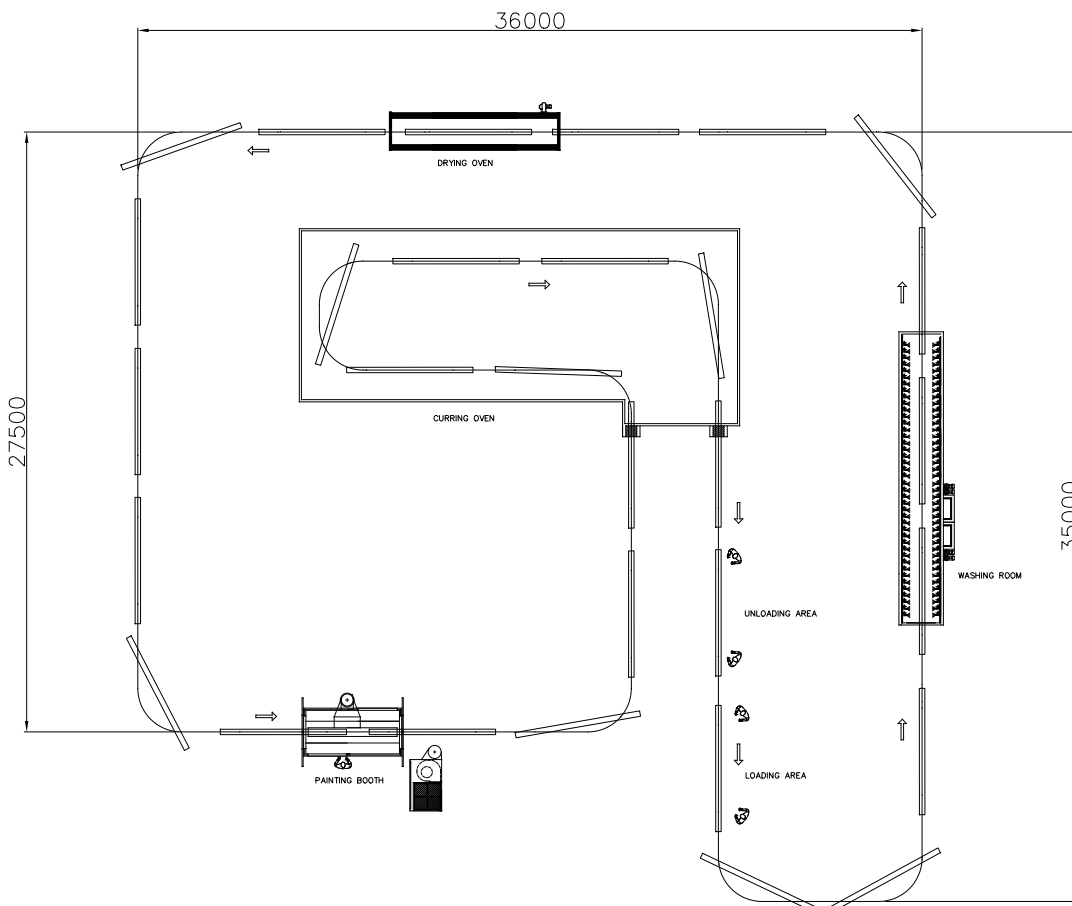

NIKO conveyor systems with crane wagons and power chain conveyor

Track Profile 24.000



Total cost of conveyor: 26.000€



Total cost of equipment: 105.000€



Required space: 360m²



Operators: 4



Painting parts / day: 860 pieces

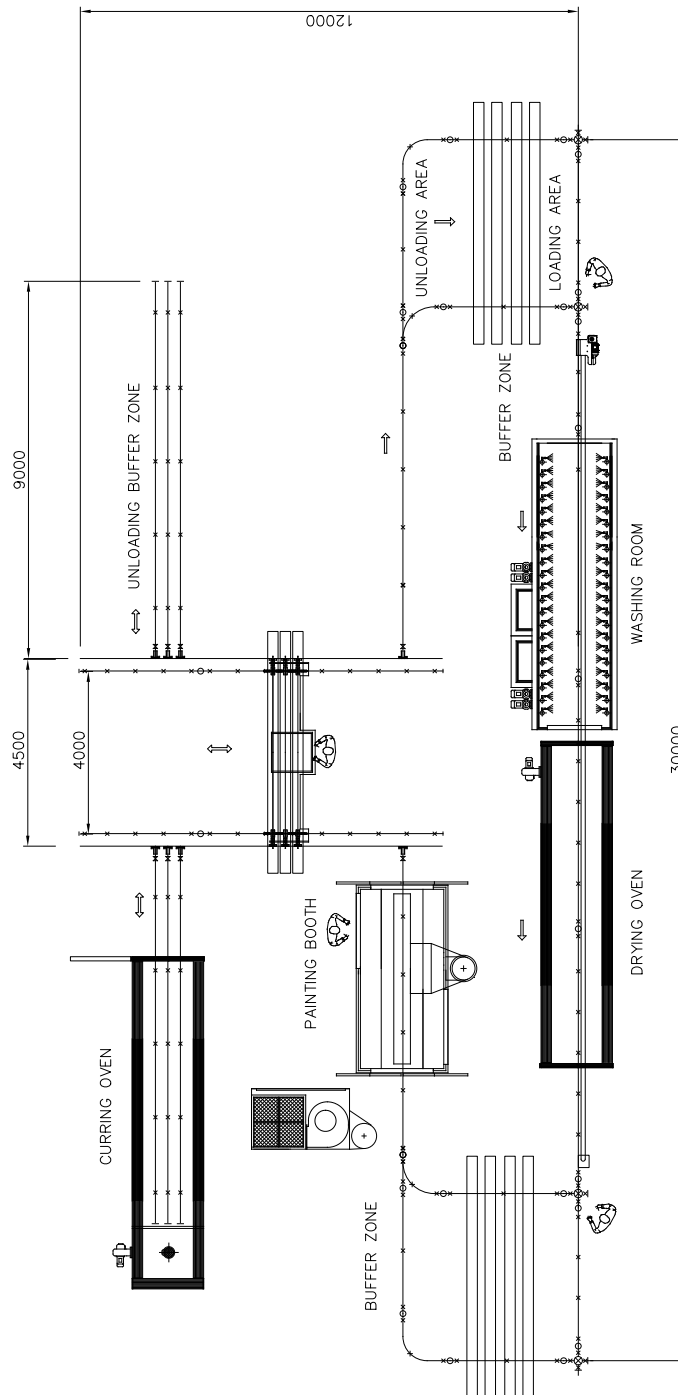

The NIKO Conveyor is considerably more profitable providing:

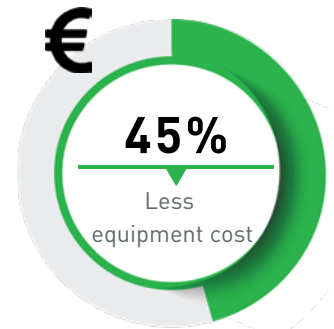
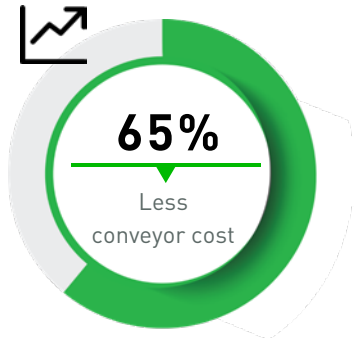

ALUMINIUM PROFILES

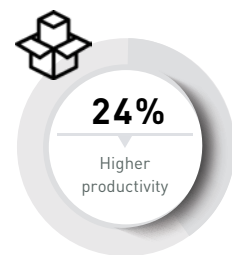
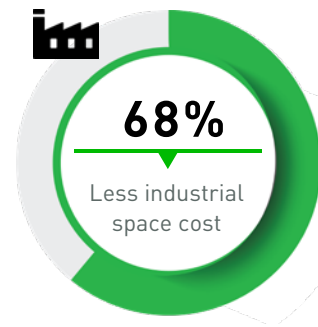



NIKO SOLUTION 2

NIKO conveyor systems with crane wagons and power chain conveyor

Track Profile 24.000

The NIKO Conveyor is considerably more profitable providing:



58%

Less conveyor cost



55%

Less equipment cost



70%

Less industrial space cost



20%

Less labor cost



25%

Higher productivity

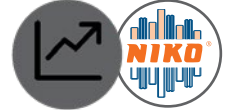
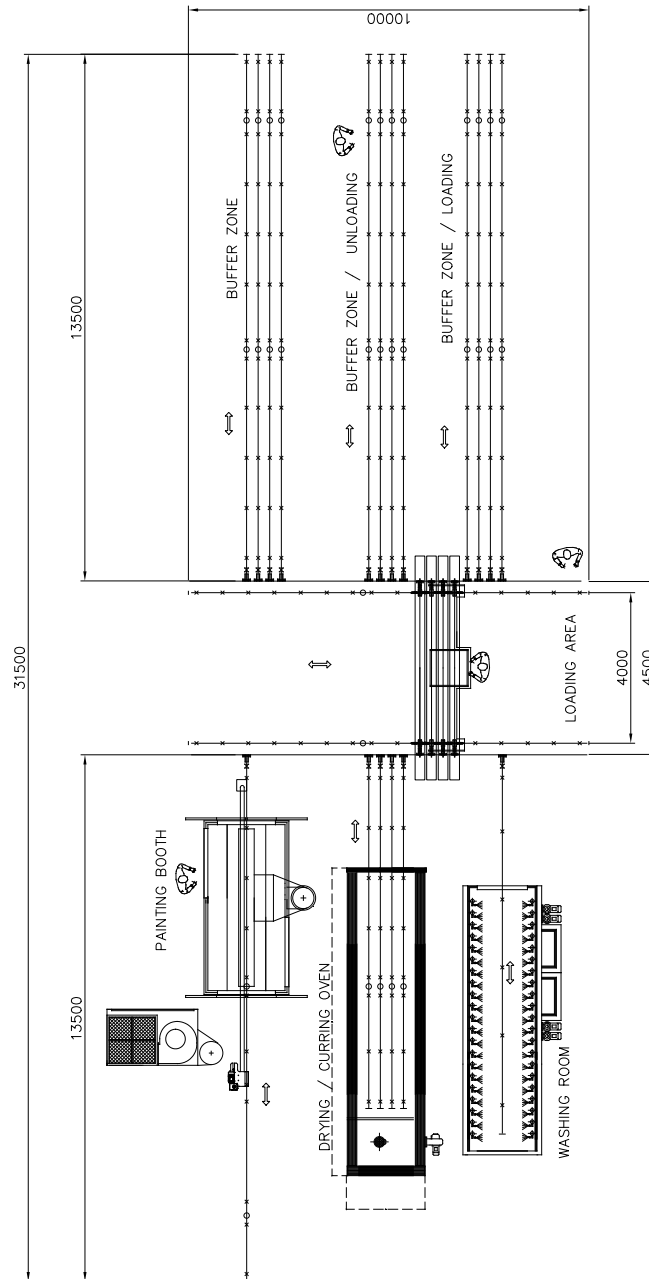

Total cost of conveyor: 31.800€



Total cost of equipment: 85.000€



Required space: 315m²



Operators: 4



Painting parts / day: 880 pieces

ALUMINIUM PROFILES

NIKO power chain conveyors

Track Profile 24.000

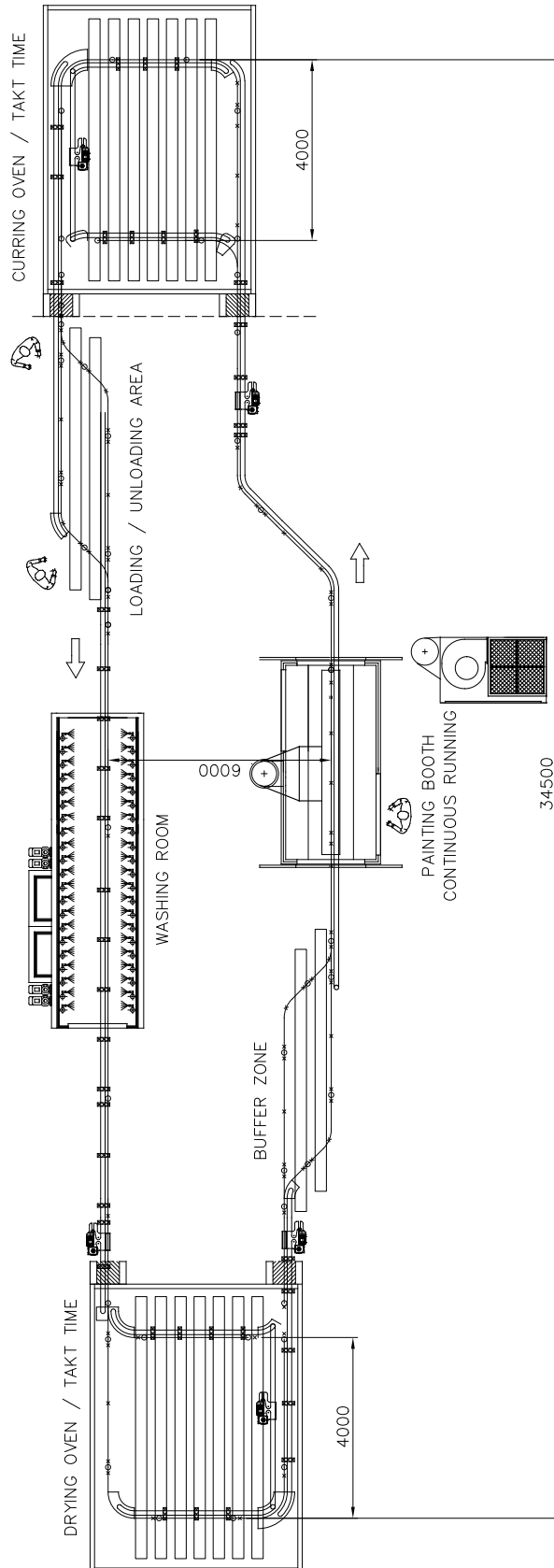

The NIKO Conveyor is considerably more profitable providing:

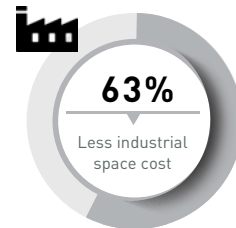
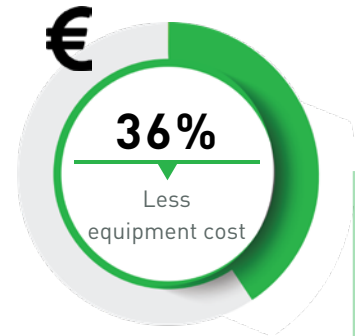
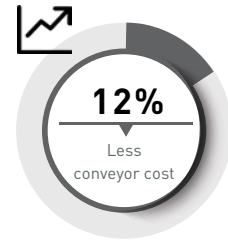

ALUMINIUM PROFILES

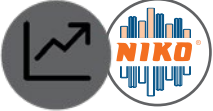

Total cost of conveyor: 66.000€



Total cost of equipment: 120.000€



Required space: 400m²



Operators: 3



Painting parts / day: 1.200 pieces

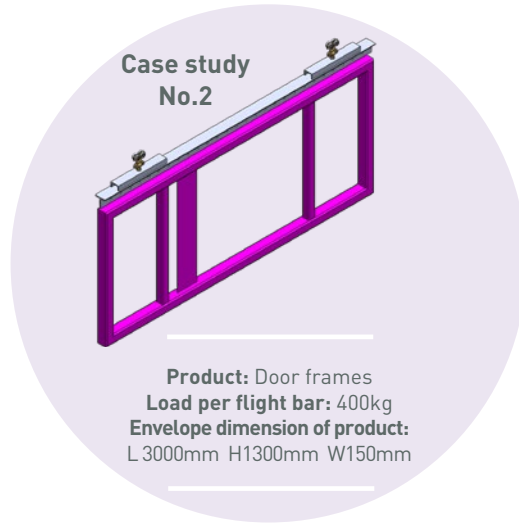

**A TYPICAL SOLUTION
 P & F
 conveyor system**

DOOR FRAMES

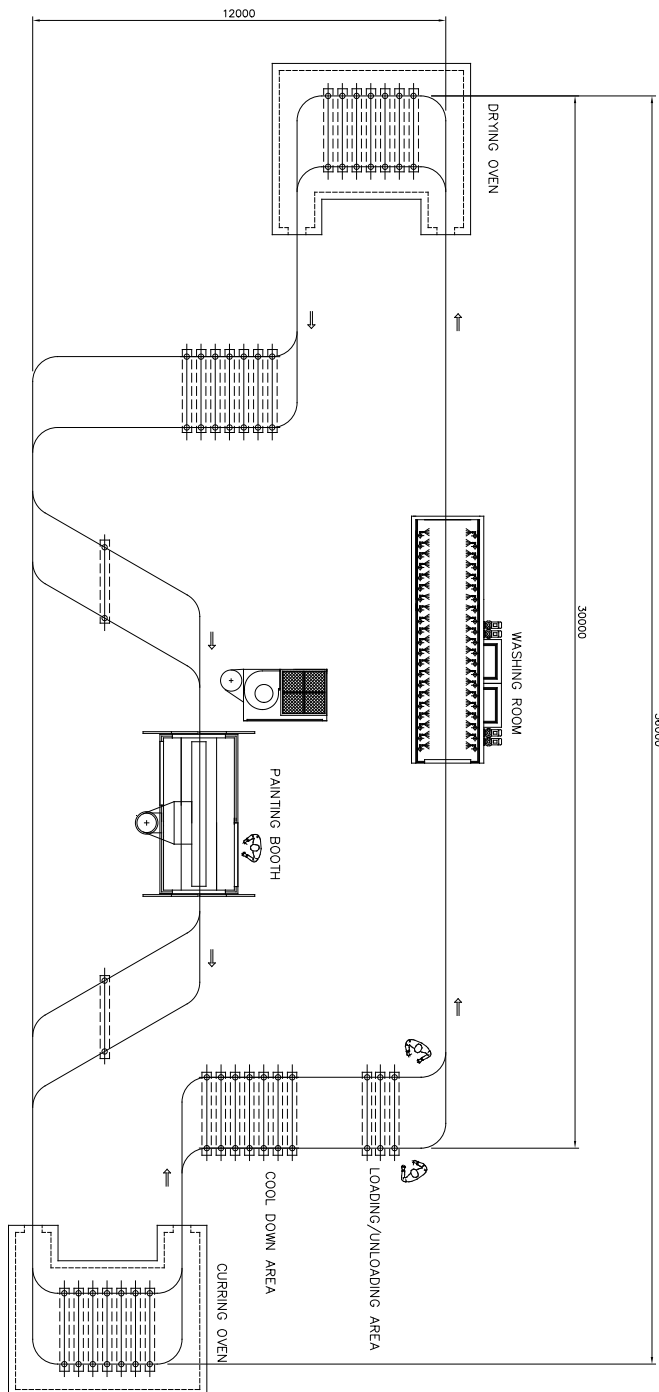

Total cost of conveyor:
120.000€



Total cost of equipment:
175.000€



Required space:
510m²



Operators: 3



Painting parts / day:
185 pieces

NIKO SOLUTION 1

NIKO power chain conveyors



Track Profile 25.000



Total cost of conveyor: 65.000€



Total cost of equipment: 125.000€



Required space: 580m²



Operators: 3



Painting parts / day: 160 pieces

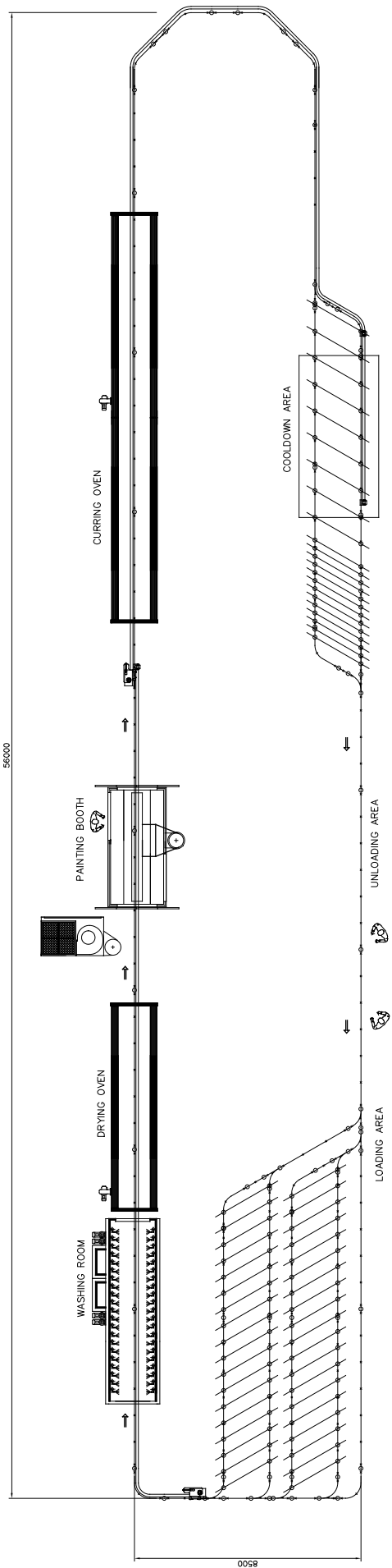

The NIKO Conveyor is considerably more profitable providing:

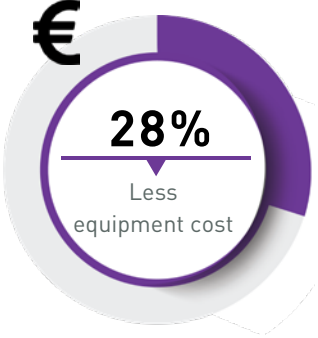
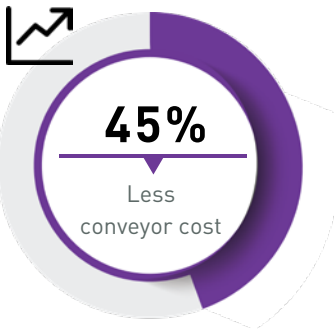

DOOR FRAMES



NIKO SOLUTION 2

NIKO conveyor systems with crane wagons

Track Profile 25.000

The NIKO Conveyor is considerably more profitable providing:



Total cost of conveyor: 22.000€



Total cost of equipment: 40.000€



Required space: 200m²



Operators: 5



Painting parts / day: 90 pieces

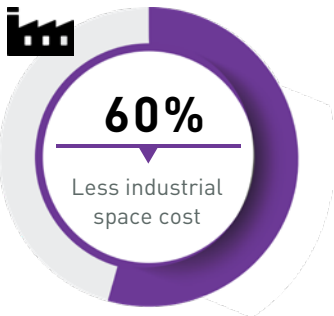
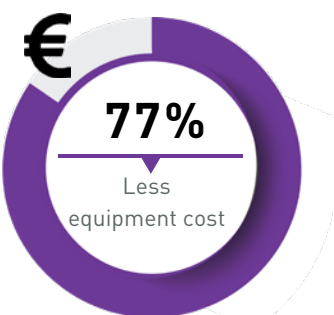
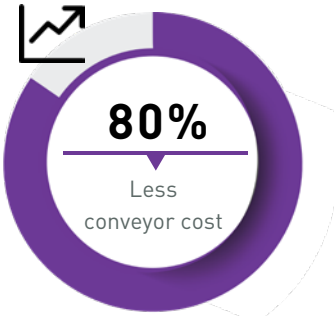

DOOR FRAMES

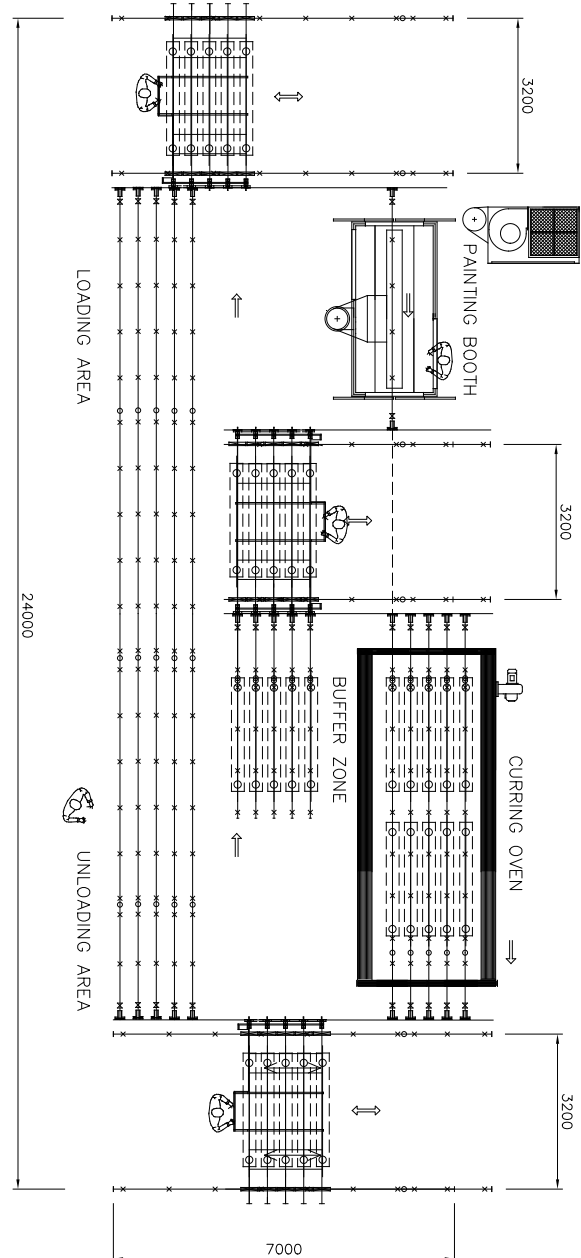

NIKO conveyor systems with power chain conveyor

NIKO SOLUTION 3



Track Profile 25.000

The NIKO Conveyor is considerably more profitable providing:

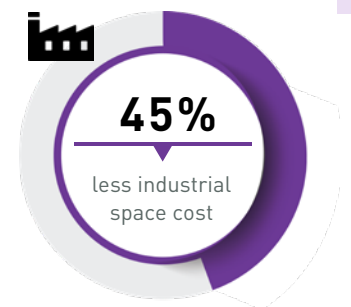
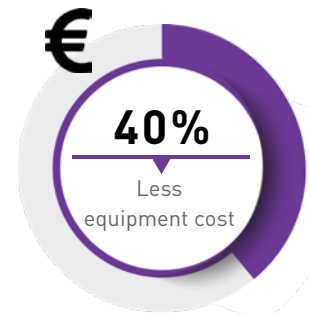
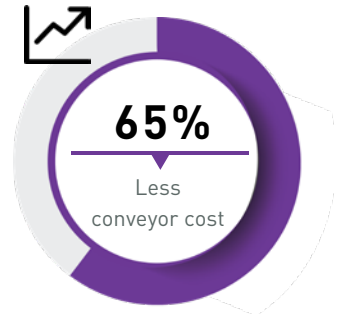

DOOR FRAMES

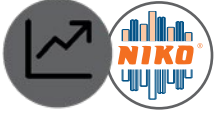
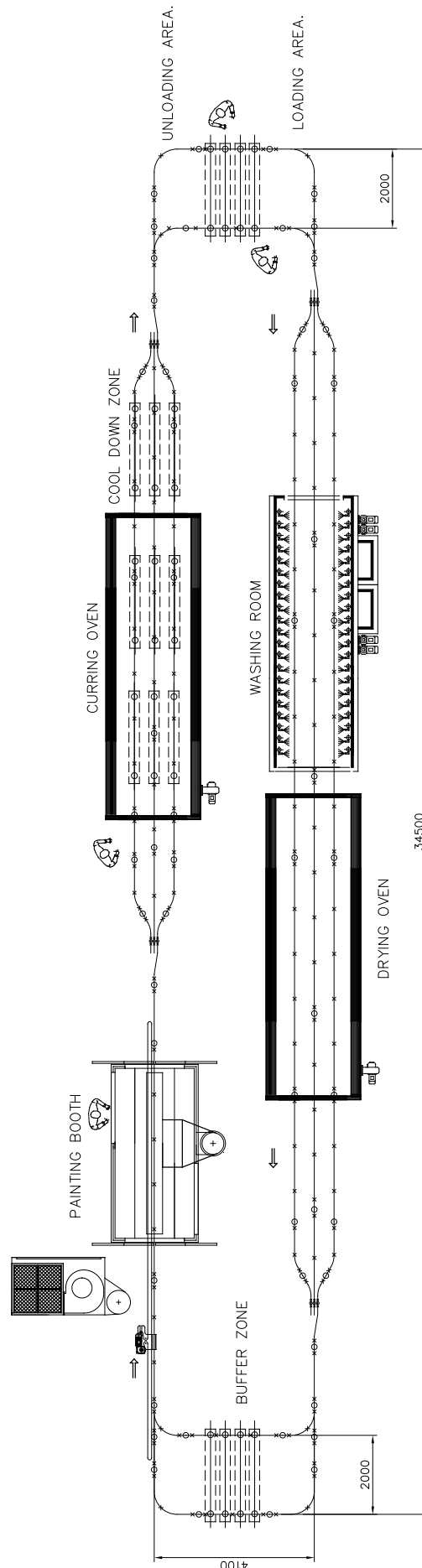

Total cost of conveyor: 41.000€



Total cost of equipment: 105.000€



Required space: 280m²



Operators: 4



Painting parts / day: 110 pieces

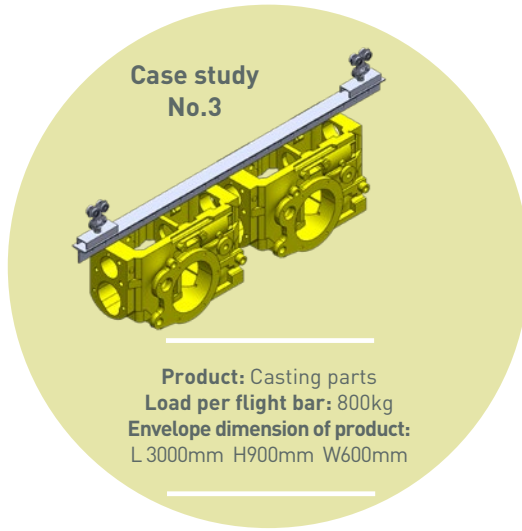

A TYPICAL SOLUTION

Painting line with forklift

CASTING PARTS

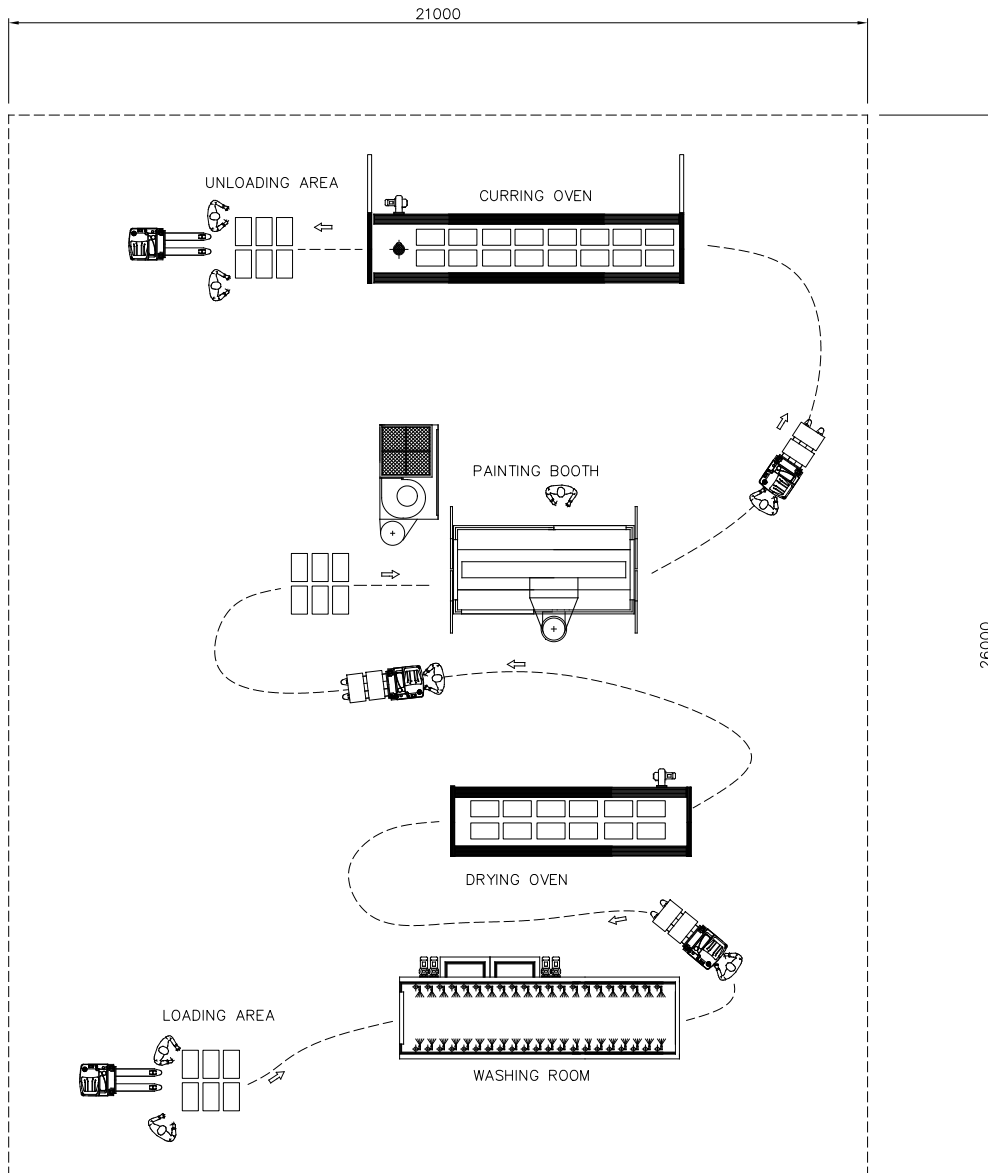

Total cost of conveyor:
25.000€



Total cost of equipment:
120.000€



Required space:
540m²



Operators: 8



Painting parts / day:
85 pieces

NIKO conveyor systems with power chain conveyor

NIKO SOLUTION 1



Track Profile 26.000

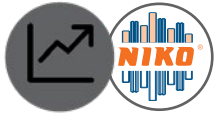

Total cost of conveyor: 32.500€



Total cost of equipment: 105.000€



Required space: 310m²



Operators: 5



Painting parts / day: 170 pieces

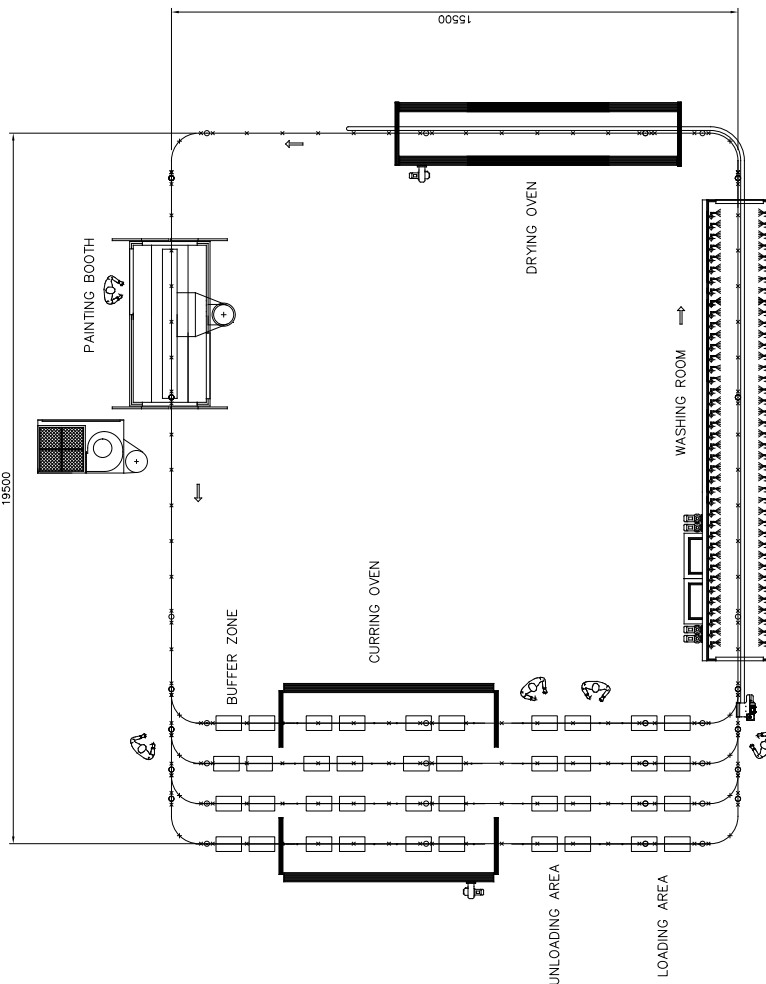

The NIKO Conveyor is considerably more profitable providing:

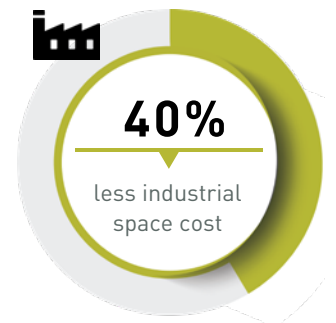
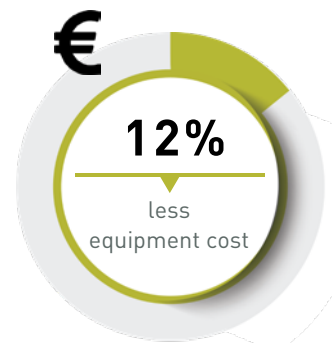

CASTING PARTS



NIKO SOLUTION 2

NIKO conveyor systems with crane wagons and power chain conveyor

Track Profile 26.000

The NIKO Conveyor is considerably more profitable providing:



25%

Less industrial space cost



50%

Less labor cost



60%

Higher productivity

CASTING PARTS

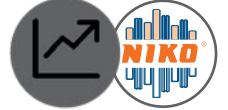
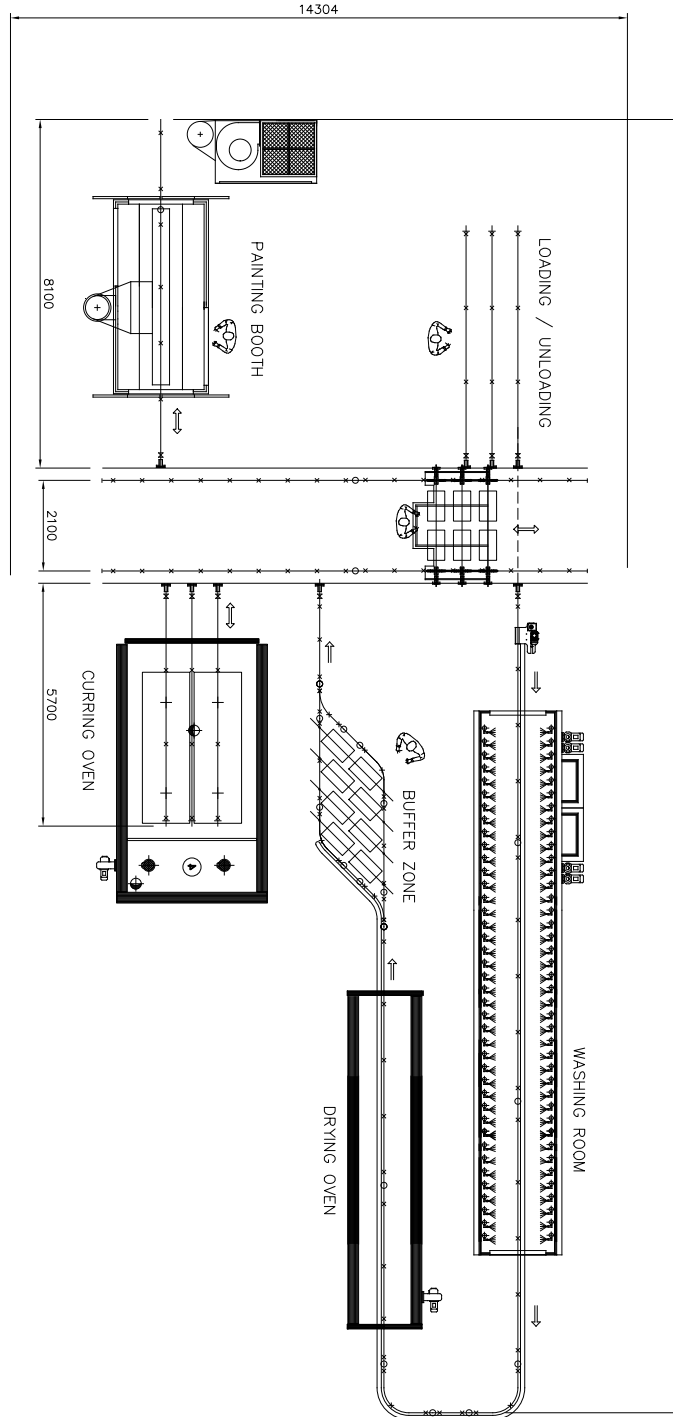

Total cost of conveyor: 42.000€



Total cost of equipment: 125.000€



Required space: 400m²



Operators: 4



Painting parts / day: 210 pieces

NIKO power chain conveyors

Track Profile 26.000

The NIKO Conveyor is considerably more profitable providing:



Total cost of conveyor: 103.000€



Total cost of equipment: 125.000€



Required space: 370m²



Operators: 3



Painting parts / day: 620 pieces

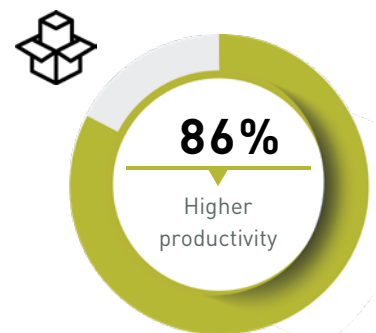
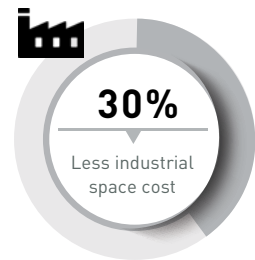
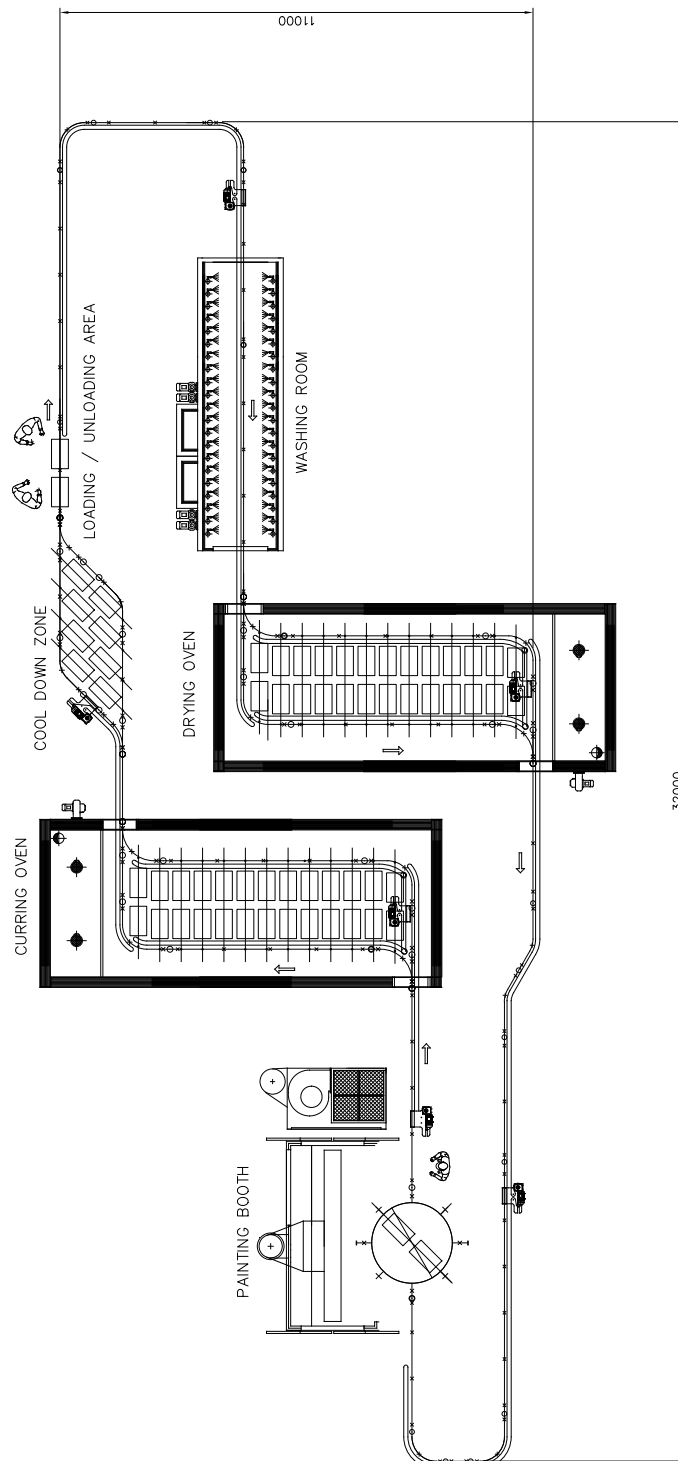

CASTING PARTS



So why buy a NIKO conveyor system?

BENEFITS OF NIKO overhead conveyor systems for painting lines over other type of Conveyors

NIKO Conveyor system

Less floor space required

Niko Overhead Conveyor requires some floor-based support structures but this can be strategically placed at facility edges and corners to minimize their footprint.

Monorails run on tracks installed directly into the ceiling and, therefore leave no footprint on the floor at all.

Avoid any re-paint procedure

Easy handling loadbars moved by hand, no contact with the painted product. Employee transfers the load hanged on loadbars and drives them through the conveyor line. The worker touch the product in the loading zone and again after the whole process is finished.

Easier manipulation of products even after exit of products from drying/curing process.

Varied of products (in size, type and weight) and bigger amount of products to be suspended on loadbar(s) at the same time, thus increase productivity.

Options of overhead parking zones for products storage before proceeding to any other process.

Multi directional options without having to occupy additional workers.

Applicable in limited spaces.

Less safety hazards for workers and equipment. Niko Overhead Conveyor reduce physical labor, provide easy moving solution for increased efficiency and reduce injuries caused by improper lifting and falling materials

Less workers needed to operate an overhead conveyor system compared to forklift systems thus increased productivity and reduce cost compared to Cart system.

Painting line with forklifts

Systems with forklifts create many facility limitations. Bulky ride-on movers generate clutter and restrict floor space because they require wide pathways and intersections to maneuver. Even when they are not in operation, forklifts and pallets with product (near to each process) and ride-on movers take up a large amount of space on the floor and get in the way of the production.

On the contrary, on systems with forklifts, products after painting must be transferred and most of the time are touching each other and paint gets scratched. When employee moves parts from powder paint to oven, most of the time the product get in touch with his body. Products get in contact and might need to be repainted meaning additional cost



Floor-movers can impose safety hazards for workers and equipment. Forklift operators must be trained and certified to operate the forklifts.

Niko power chain conveyor

Niko Systems occupy less space.

Ovens can be build smaller thus save money on equipment, on energy fuels and no big heat lose.

Easier handling of loading and unloading zones since they are free of chain.

With Niko System the customer has the option to create parking zones in different areas like masking or inspection areas.

Niko System costs less.

Easily modified when a customer needs to make an extension.

Safe.

When the system is running you can touch the track without danger.

NIKO enclosed track profile ensures that the bearings are not exposed to the environment therefore cause damage to trolley.

Continuous running automatic power chain conveyor



In Continuous Running Automatic Power Chain Conveyors the doors remain always open and that results to serious heat lose and cost increase.



In Continuous Running Automatic Power Chain Conveyors it is difficult to load/unload products since the system is in continuous movement. Theremore, it is not possible to make parking zones to load/unload products or buffer zones to mask the technological holes on products before painting and after painting.





**AUSTRIA-NIKO Vertriebs GmbH**

Hainfelder Straße 48
 A - 2560 Berndorf
 Tel. 0043 2672-21201
 Fax 0043 2672-21201-13
office.at@niko.eu.com
www.niko.world

CHINA-NIKO TRADING (SHANGHAI) Co., Ltd

Room 605, Building #13, No.354
 Linghe Road, Pudong District,
 P.R.China - 200120 Shanghai
 Tel. 0086 139 1814 5645
info.cn@niko.eu.com

GERMANY-NIKO Technik GmbH

Robert-Bosch-Str. 14
 DE - 42489 Wülfrath
 Tel. 0049 (0) 2058 9093603
 Fax 0049 (0) 2058 9093604
office.de@niko.eu.com

GREECE-Helm Hellas S.A.

82nd Km Athens-Korinthos
 P.O. Box 209
 GR - 201 00 KORINTHOS
 Tel. 0030 27410 76800
 Fax 0030 27410 25368
info@niko.eu.com

POLAND- NIKO Polska

Wojska Polskiego 65A
 PL - Wielun 98-300
 Tel. 0048 504 00 35 56
info.pl@niko.eu.com

UNITED KINGDOM-NIKO Ltd

Units 15-21, Insight Park
 Welsh Road East, Southam
 Warwickshire, CV47 1NE -UK
 Tel. 0044 (0) 1926 813111
 Fax 0044 (0) 1926 815599
Sales@niko.co.uk
www.niko.co.uk

USA-NIKO Track

300 Highpoint Ave
 USA - Portsmouth, RI. 02871
 Tel. 001 (0) 401 683 7525
 Fax 001 (0) 401 293 3848
info@nikotrack.com
www.nikotrack.com

Copyright NIKO Version June 2018
 We take no obligation for layout, composition, technical modifications as well as misprints.
 Subject to technical modifications / images can be differ from original.

www.niko.eu.com www.niko.co.uk www.nikotrack.com www.niko.world

Your **NIKO** agent will be happy to advise you:

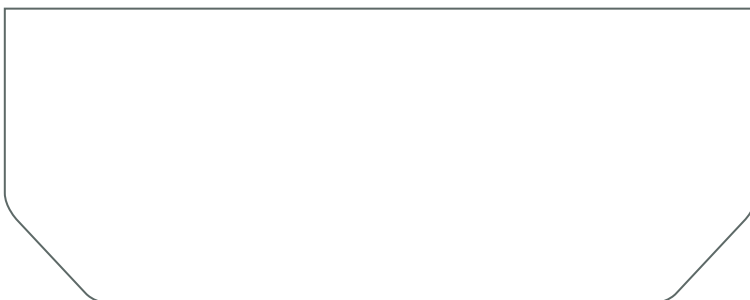

Complete **NIKO** product range:

- LIGHT DUTY SLIDING DOOR HARDWARE
- HEAVY DUTY SLIDING DOOR HARDWARE
- CONVEYOR SYSTEMS
- LIGHT CRANES
- CABLE TROLLEYS, FESTOON SYSTEMS & CONDUCTOR BARS
- PERSONAL FALL ARREST SYSTEMS (EN 795)
- ACCESSORIES FOR GATES AND DOORS